

Unleash the Power of COOL

Seamless Integration, Cutting-Edge Features and Empowered Collaboration

Michael Meeks
CEO

michael.meeks@collabora.com



Collabora Online

Powerful Online Collaboration

What is Collabora Online?

Documents + Spreadsheets + Slides + Drawings

- Viewing and collaborative editing
- Feature rich

Interoperability with Microsoft formats

- docx, doc, rtf, xlsx, xls, pptx, ppt

Import filters and viewing for

- PDF, Visio, Publisher and many more

Powerful WYSIWYG rendering

On-premise integration

Architecture – a bet on CPU threads and network getting cheaper over time.



Collaborative Writer

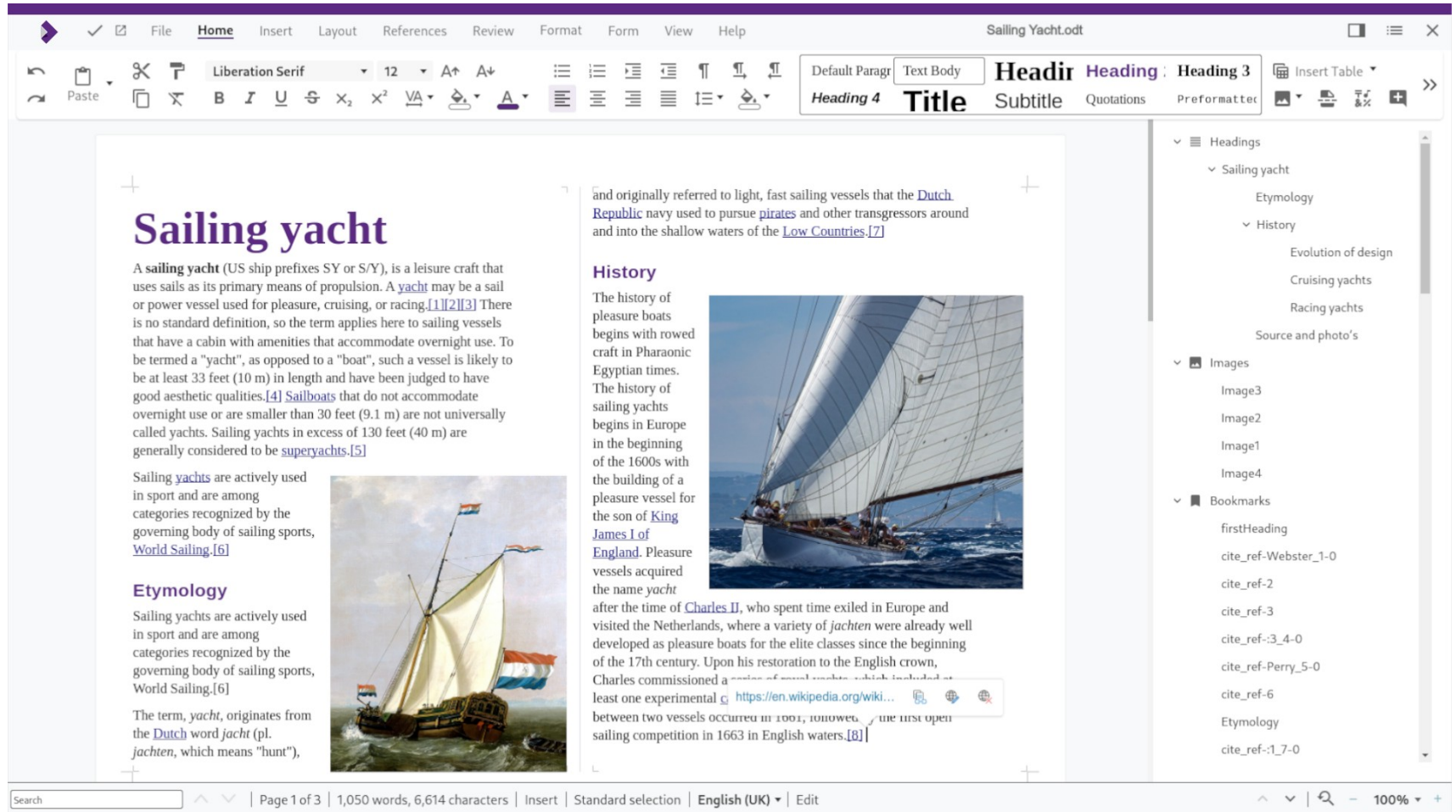

The screenshot displays the Collaborative Writer application interface. At the top, a menu bar includes options like File, Home, Insert, Layout, References, Review, Format, Form, View, and Help. Below the menu is a toolbar with various editing tools and a style selector showing 'Heading 3' and 'Title'. The main workspace contains a document titled 'Sailing Yacht.odt' with a heading 'Sailing yacht' and several paragraphs of text. A sidebar on the right shows a table of contents with sections like 'Sailing yacht', 'History', and 'Etymology'. The status bar at the bottom indicates 'Page 1 of 3', '1,050 words, 6,614 characters', and 'English (UK)'.

Sailing yacht

A **sailing yacht** (US ship prefixes SY or S/Y), is a leisure craft that uses sails as its primary means of propulsion. A **yacht** may be a sail or power vessel used for pleasure, cruising, or racing.[1][2][3] There is no standard definition, so the term applies here to sailing vessels that have a cabin with amenities that accommodate overnight use. To be termed a "yacht", as opposed to a "boat", such a vessel is likely to be at least 33 feet (10 m) in length and have been judged to have good aesthetic qualities.[4] **Sailboats** that do not accommodate overnight use or are smaller than 30 feet (9.1 m) are not universally called yachts. Sailing yachts in excess of 130 feet (40 m) are generally considered to be **superyachts**.^[5]

Sailing **yachts** are actively used in sport and are among categories recognized by the governing body of sailing sports, [World Sailing](#).^[6]

Etymology

Sailing yachts are actively used in sport and are among categories recognized by the governing body of sailing sports, [World Sailing](#).^[6]

The term, *yacht*, originates from the [Dutch](#) word *jacht* (pl. *jachten*, which means "hunt"),

and originally referred to light, fast sailing vessels that the [Dutch Republic](#) navy used to pursue [pirates](#) and other transgressors around and into the shallow waters of the [Low Countries](#).^[7]

History

The history of pleasure boats begins with rowed craft in Pharaonic Egyptian times. The history of sailing yachts begins in Europe in the beginning of the 1600s with the building of a pleasure vessel for the son of [King James I of England](#). Pleasure vessels acquired the name *yacht* after the time of [Charles II](#), who spent time exiled in Europe and visited the Netherlands, where a variety of *jachten* were already well developed as pleasure boats for the elite classes since the beginning of the 17th century. Upon his restoration to the English crown, Charles commissioned a [series of naval yachts](#) which included at least one experimental <https://en.wikipedia.org/wiki/...> between two vessels occurred in 1664, followed by the first open sailing competition in 1663 in English waters.^[8]

Collaborative Spreadsheets

Microsoft Excel interface showing a dashboard for GuitarMoonShop.com. The dashboard includes a SERP Rank chart, a table of page performance metrics, and a summary of organic sources and traffic.

SERP Rank Chart: Shows the ranking of various products over time from 01/01/16 to 12/12/16. The products tracked are: Guitar Straps, Bass Guitar Pick, Gibson Acoustic, Marshall Amp, Les Paul Guitar, Gibson Acoustic, Peavey Amp, Fender Black amp, Hollowbody guitar, and Mesa Boogie amp.

Page Performance Table:

Page	Backlinks	Indexed URLs	URLs	Non-Paid Search	Conversions	Signups
page-1/	953		637	Guitar Straps	38	10
page-2/				Bass Guitar Pick	236	197
page-3/				Gibson Acoustic	143	90
page-4/				Marshall Amp	550	391
page-5/	18			Les Paul Guitar	90	37
page-6/	32			Gibson Acoustic	762	497
page-7/	9			Peavey Amp	311	212
page-8/	11			Fender Black amp	364	259
page-9/	40			Hollowbody guitar	258	213
page-10/	20			Mesa Boogie amp	656	338

Organic Sources Summary:

Organic Sources	% of Visits	Revenue	% of revenue	Traffic	Goals	WTD	MTD
Google	70%	\$494,296.97	74%	Non-Paid Search Traffic	11,000 wk	1605175%	62,681
Yahoo	15%	\$104,563.64	16%	Non-paid Search Revenue	8000 wk	\$11,180.04	\$47,942.26

Collabora Online logo and interface elements are visible at the bottom of the image.

Collaborative Drawing

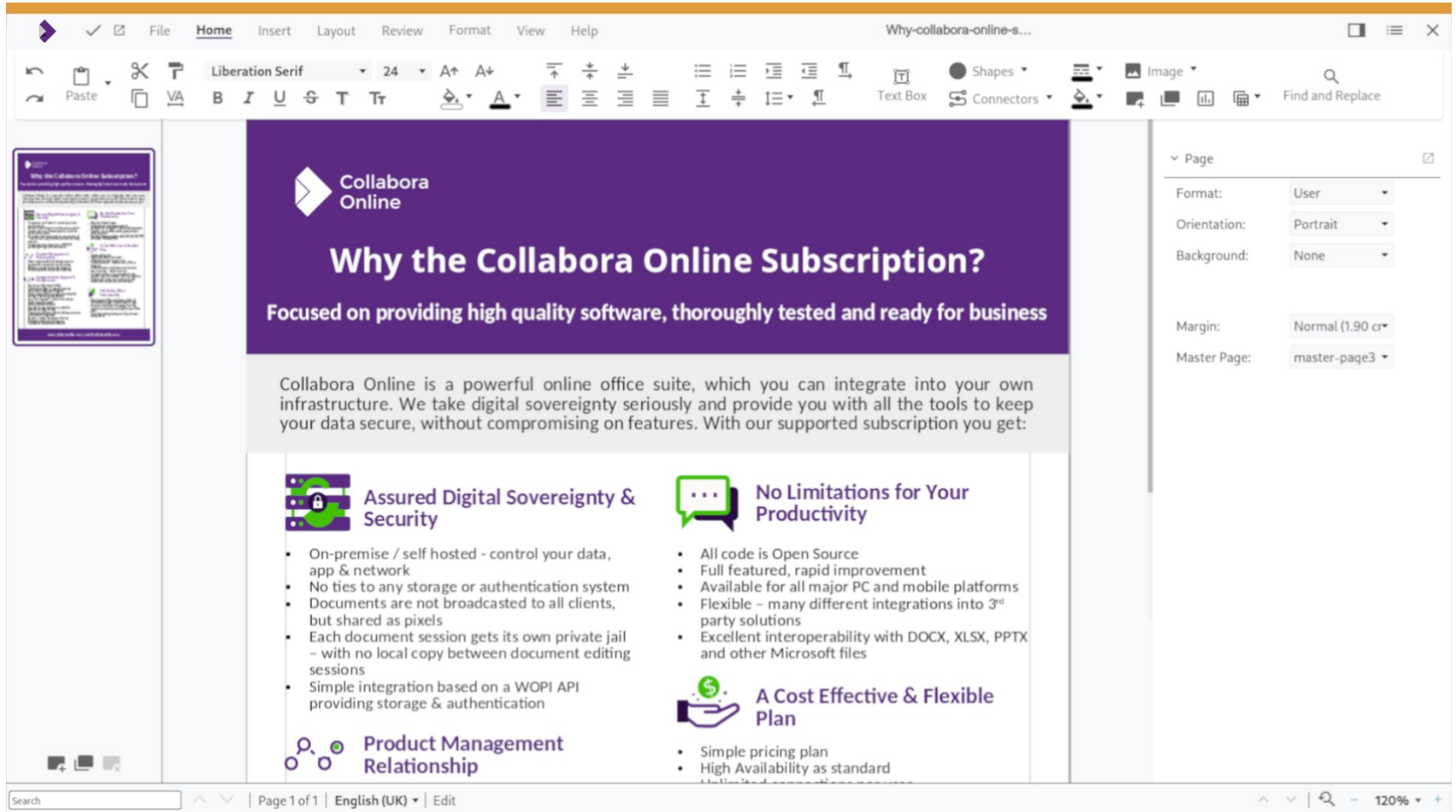

Collabora Online

Why the Collabora Online Subscription?

Focused on providing high quality software, thoroughly tested and ready for business

Collabora Online is a powerful online office suite, which you can integrate into your own infrastructure. We take digital sovereignty seriously and provide you with all the tools to keep your data secure, without compromising on features. With our supported subscription you get:

Assured Digital Sovereignty & Security

- On-premise / self hosted - control your data, app & network
- No ties to any storage or authentication system
- Documents are not broadcasted to all clients, but shared as pixels
- Each document session gets its own private jail - with no local copy between document editing sessions
- Simple integration based on a WOPI API providing storage & authentication

No Limitations for Your Productivity

- All code is Open Source
- Full featured, rapid improvement
- Available for all major PC and mobile platforms
- Flexible - many different integrations into 3rd party solutions
- Excellent interoperability with DOCX, XLSX, PPTX and other Microsoft files

Product Management Relationship

A Cost Effective & Flexible Plan

- Simple pricing plan
- High Availability as standard

Page 1 of 1 | English (UK) | Edit | 120%

Collaborative Presentations

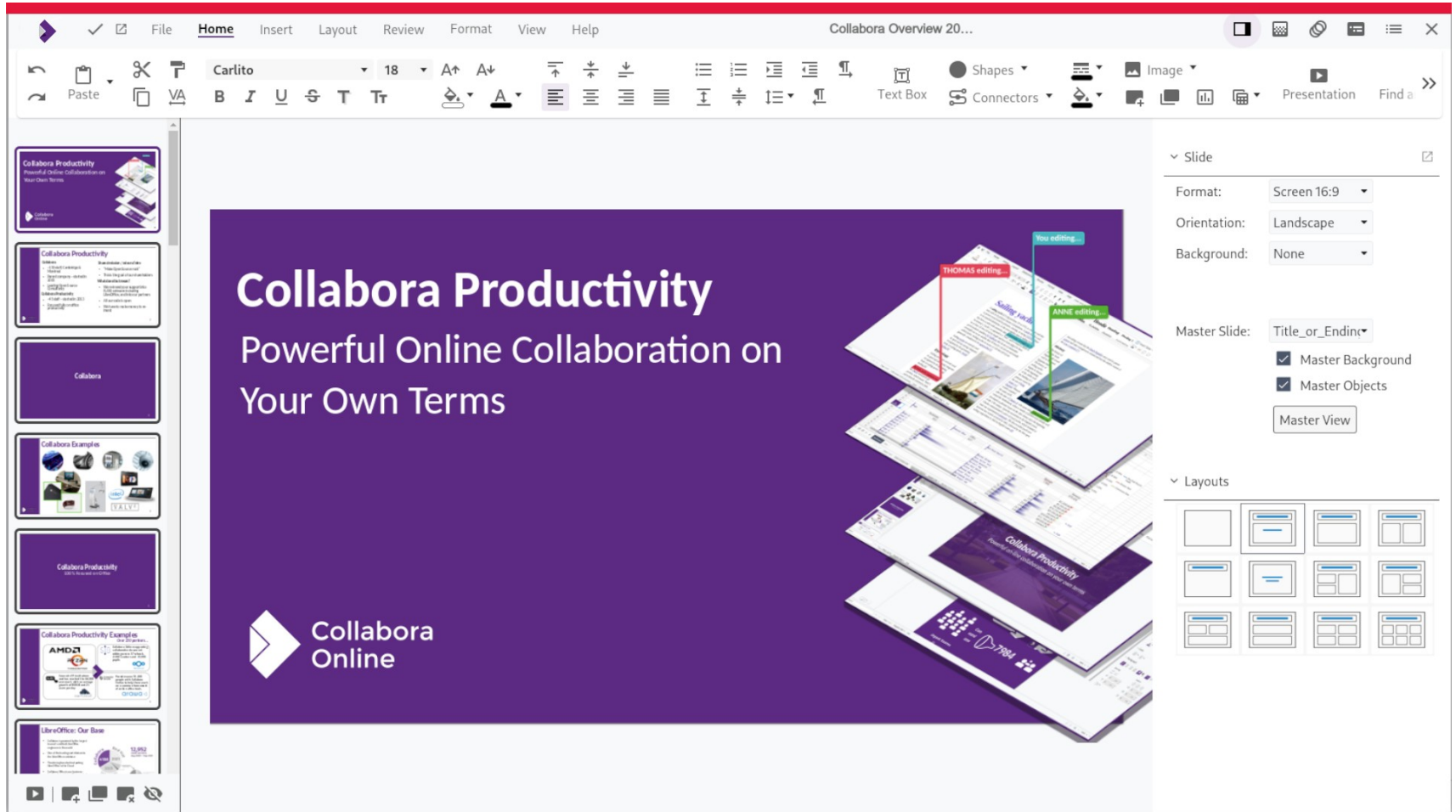

The screenshot displays the Collabora Online presentation editor interface. At the top, a menu bar includes 'File', 'Home', 'Insert', 'Layout', 'Review', 'Format', 'View', and 'Help'. Below the menu is a ribbon with various editing tools such as 'Paste', 'Undo', 'Redo', 'Text Box', 'Connectors', and 'Image'. The main workspace shows a presentation slide with a dark purple background and white text: 'Collabora Productivity' and 'Powerful Online Collaboration on Your Own Terms'. The slide also features the Collabora Online logo and a stack of overlapping presentation slides. On the right side, a 'Slide' panel is visible, showing settings for 'Format' (Screen 16:9), 'Orientation' (Landscape), and 'Background' (None). Below this, the 'Master Slide' section is set to 'Title_or_Ending' and includes checkboxes for 'Master Background' and 'Master Objects', along with a 'Master View' button. At the bottom right, a 'Layouts' panel displays a grid of 12 different slide layout templates.

Collabora for Android, iOS & Chromebooks

Also available on Desktop, Mobile & Chrome OS



Collabora Online for Education



Case Study

Open Source helps students learn from home during lockdown



Case Study

SIB delivering Nextcloud to 2500 teachers and 33000 pupils in Brittany, France



Case Study

How Arawa and Collabora Online Have Helped Students & Staff Better Collaborate at the University of Lille, France



Case Study

How ownCloud and Collabora Online Increased Productivity In the Dutch University and Research Landscape



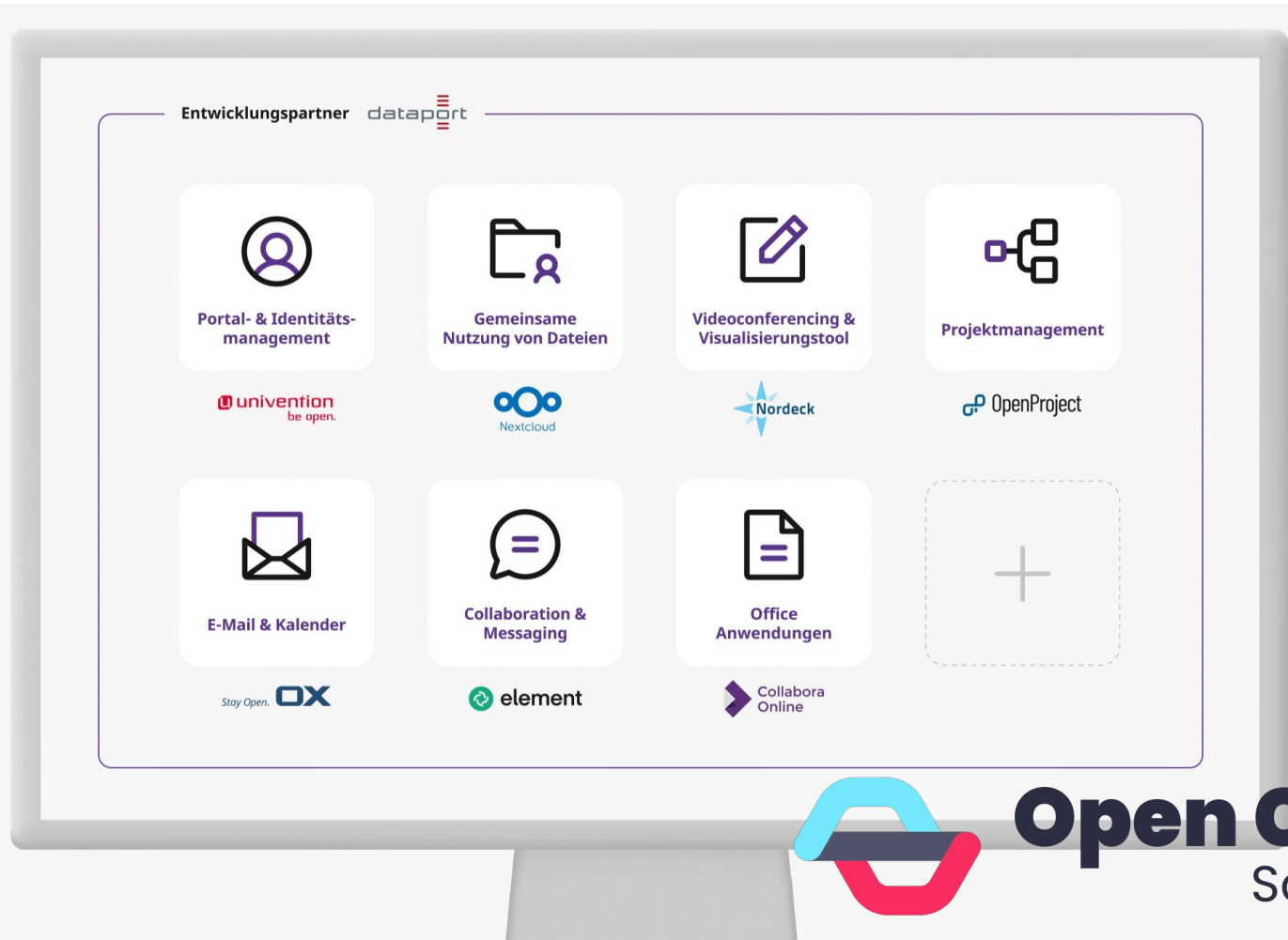

Collabora Online

Distinctives

Friendly Open Source Project



Real Open Source

- 100% open-source code
- Built with LibreOffice technology
- Built with Free Software technology stacks: primarily C++
- Runs best on Linux

Open Development

- Anyone can contribute & participate
- Follow commits and tickets
- Public community calls - forum has details

Focus:

- a non-renewable resource.
- Office Productivity & Documents
- Excited about migrating your documents
- Grateful to our partners for solving other problems.



Friendly Open Source Business

Responsive Support

- Standing behind our customers
- ISO 9001, and ISO 27001 certified

Sensible licensing

- As many servers & connections & containers & VMs as you need

“Office for the free world”

- Friendly Developers
 - 50% EU, 75% NATO, global org + LibreOffice technology community
- Friendly Investors
 - 50/50 ~Canada / UK
- Engineers that can travel to you
- Clean hands.

Document Security

Untrusted Clients

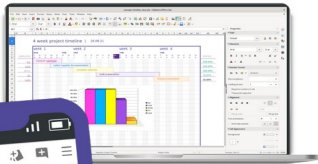
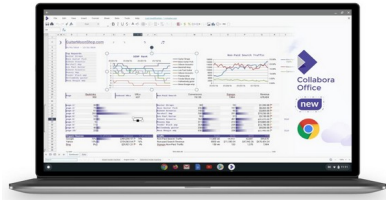

Sending *pixels* to screens

Firewall
VPN
Proxy

Trusted, Secure, Collabora Online Server

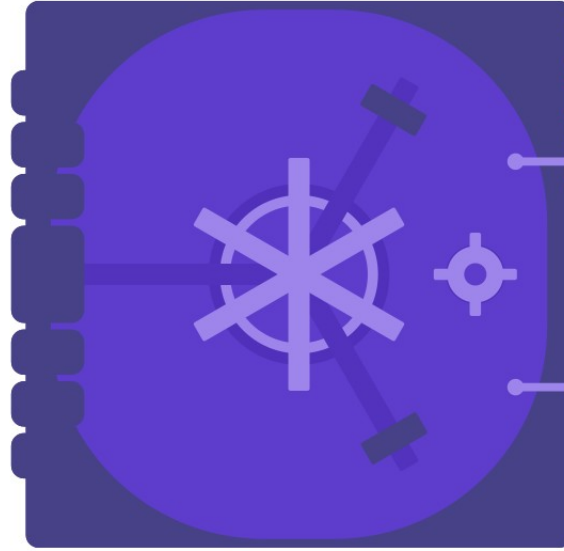

- on your premise / Private network
- Virtual machine / Docker container
- Seccomp-bpf ~no sys-calls
- Extremely sparse filesystem
- Chroot per document
- Systematic load crash testing
- Industry beating coverity score
- LibreOfficeKit rendering instance

Load-balanced
Redundant
Instances

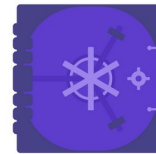
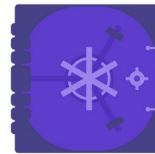
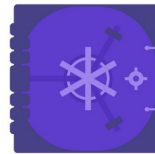

- on your premise / Private network
- Virtual machine / Docker container
- Seccomp-bpf ~no sys-calls
- Extremely sparse filesystem
- Chroot per document
- Systematic load crash testing
- Industry beating coverity score
- LibreOfficeKit rendering instance

Highly available & simply scalable

eg. grab our helm-chart

- Incremental / available upgrade-ability
- No extra services
- Management (eg. Kubernetes)

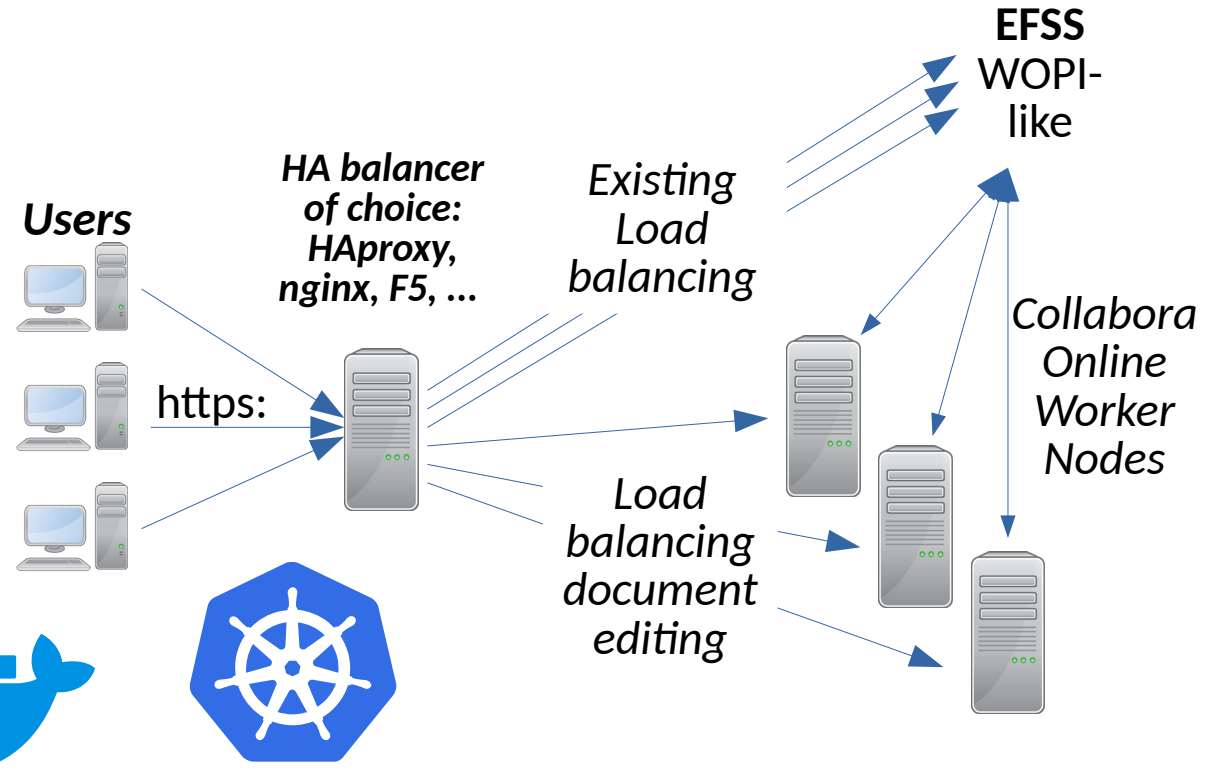
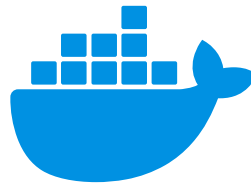

COOL Controller:

Even easier deployment & scaling

Scaling Collabora Online with Kubernetes

- Load scaling example – target pod utilisation <70%



Scaling Collabora Online with Kubernetes

- Load scaling example – pod under-utilisation

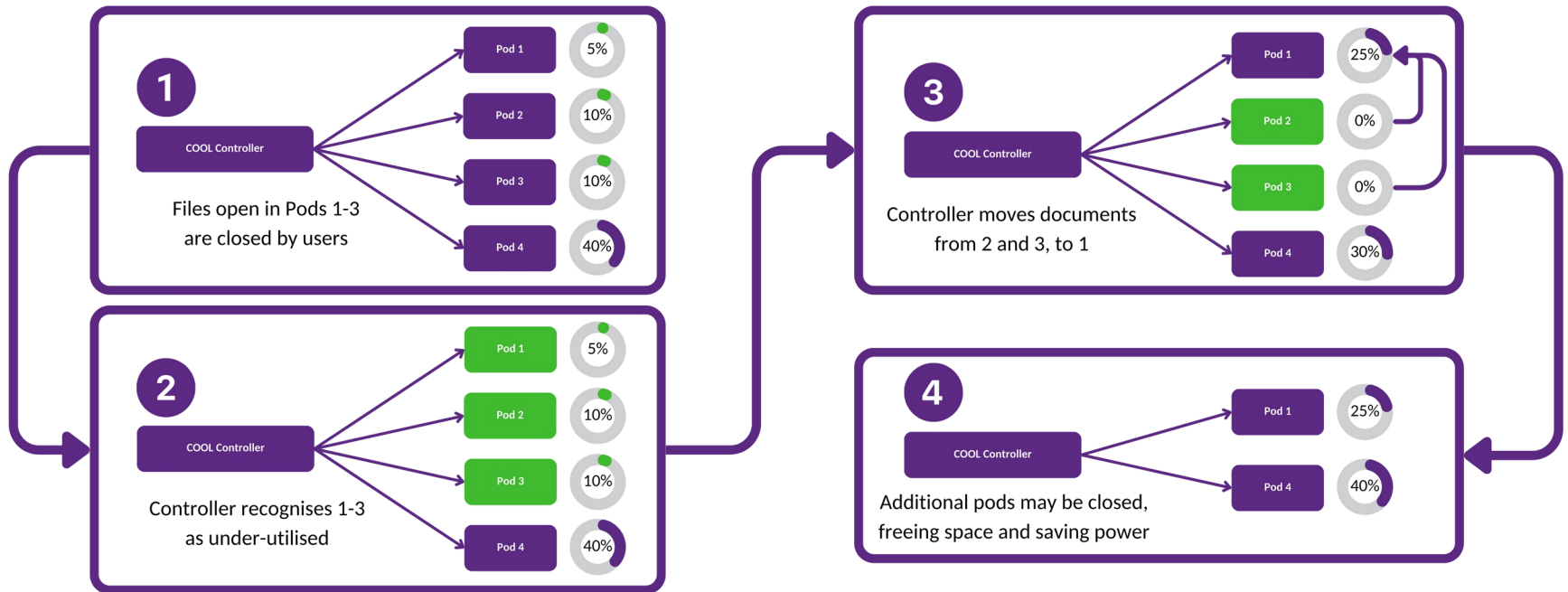

Latest Features in 23.05

since last CS3

Collabora Online

Accessibility Features



Dark Mode

Initial Screen Reading Support

Keyboard Navigation

Accessibility Checker

PDF/UA

Find out more: [col.la/accessibility](https://collabora.com/la/accessibility)

Accessibility

Generating accessible PDFs with PDF/UA export

- Tagged PDF, PDF forms, Universal Accessibility for PDFs, and many more options when exporting available in last year.

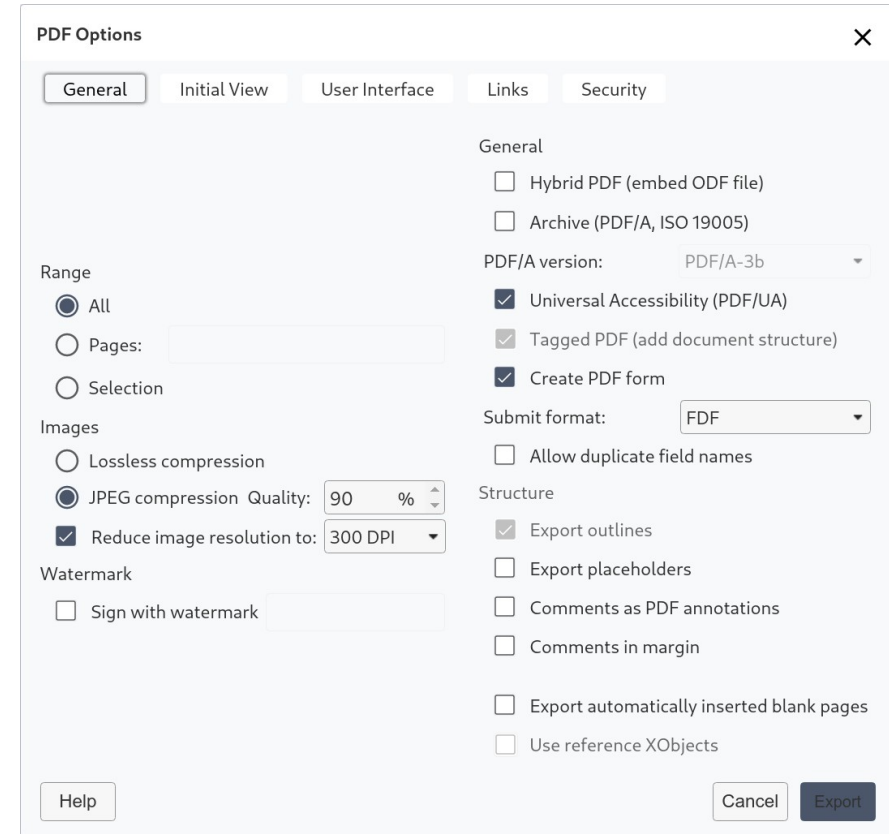

PDF Options [Close]

General | Initial View | User Interface | Links | Security

General

- Hybrid PDF (embed ODF file)
- Archive (PDF/A, ISO 19005)
- PDF/A version: PDF/A-3b
- Universal Accessibility (PDF/UA)
- Tagged PDF (add document structure)
- Create PDF form
- Submit format: FDF
- Allow duplicate field names

Range

- All
- Pages: []
- Selection

Images

- Lossless compression
- JPEG compression Quality: 90 %
- Reduce image resolution to: 300 DPI

Watermark

- Sign with watermark []

Structure

- Export outlines
- Export placeholders
- Comments as PDF annotations
- Comments in margin
- Export automatically inserted blank pages
- Use reference XObjects

[Help] [Cancel] [Export]

Accessibility

Keyboard accelerators

- Expansion for languages
 - Keyboard shortcuts have been expanded to allow all users to be able to use their own language's keyboard shortcuts when editing a file collaboratively.
 - Holding down the 'Alt' key will also highlight options for learnability.

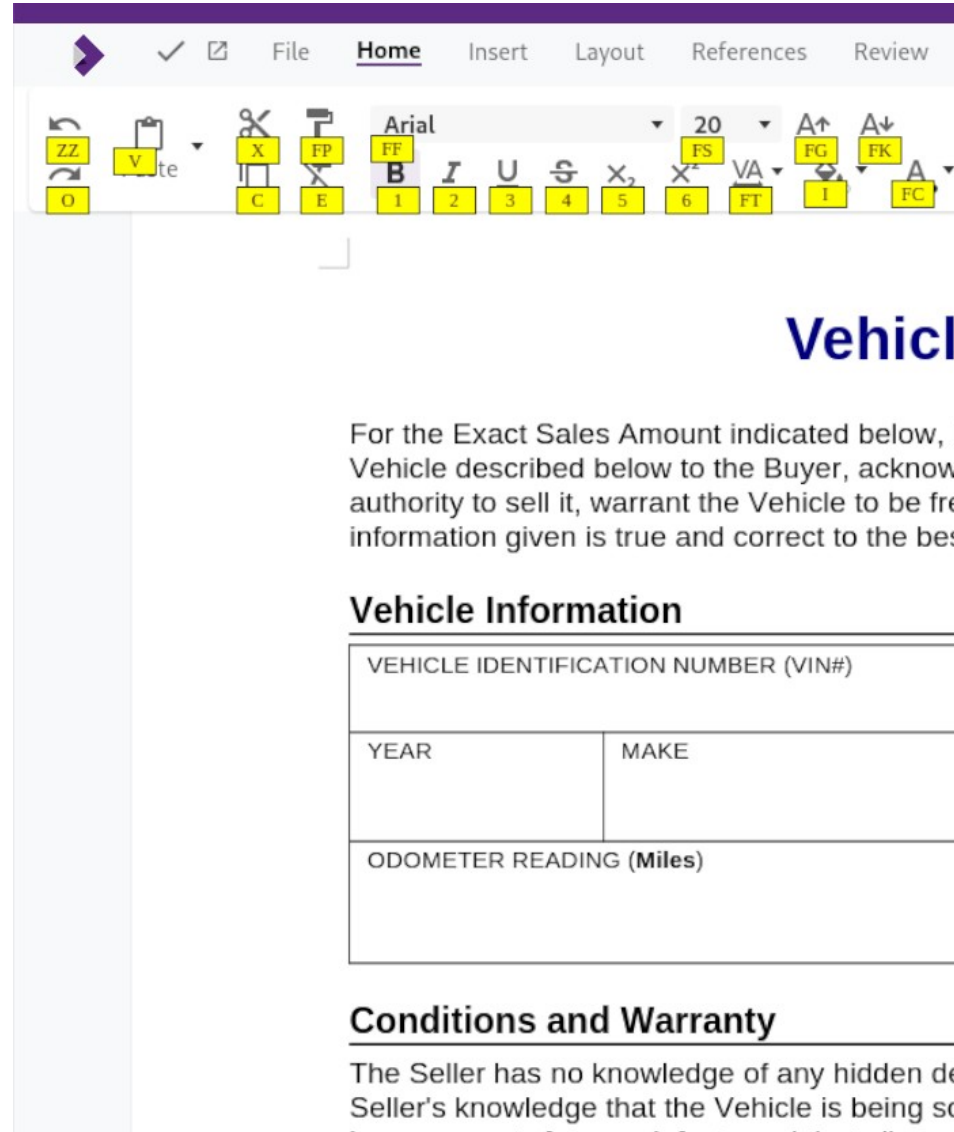

Accessibility – Dark mode

Also added various UI properties per-view:
eg. non-printing characters, spell-underlines etc.

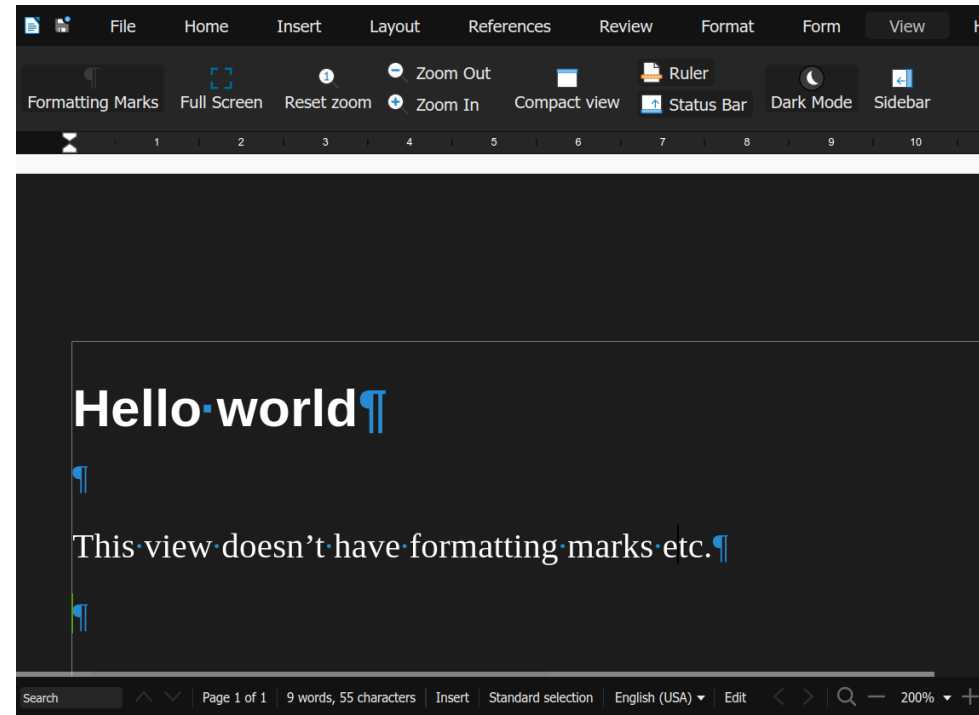
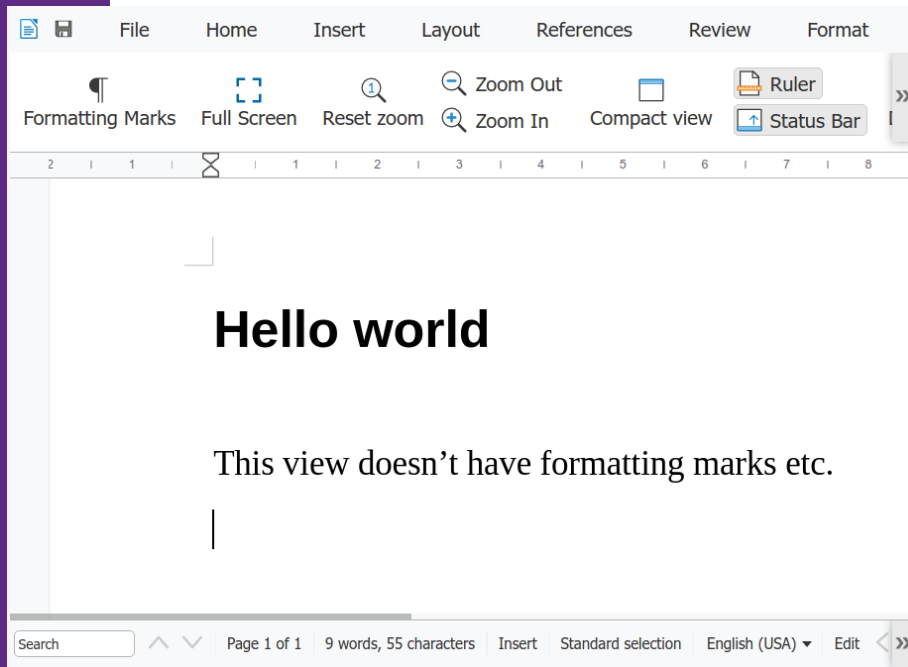

Accessibility

Page Navigation

- Navigator functionality is viewable in the sidebar, allowing you to jump to each section by simply clicking the headings.

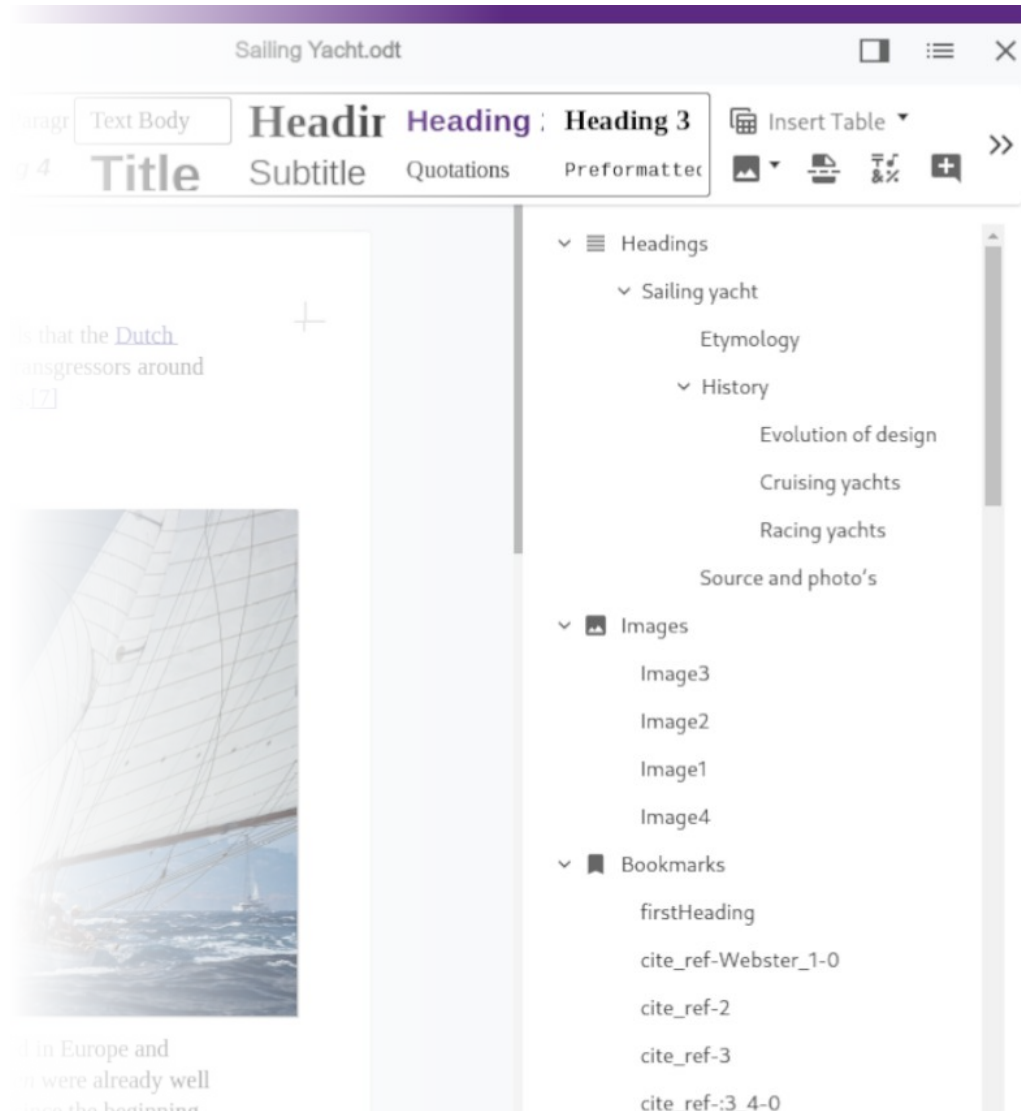

Recent Features

Interoperability

Examples

Interoperability

Document themes – controlling branding

- Document themes can be configured and applied to a whole document to easily change and re-purpose the appearance, giving it a consistent style and branding.

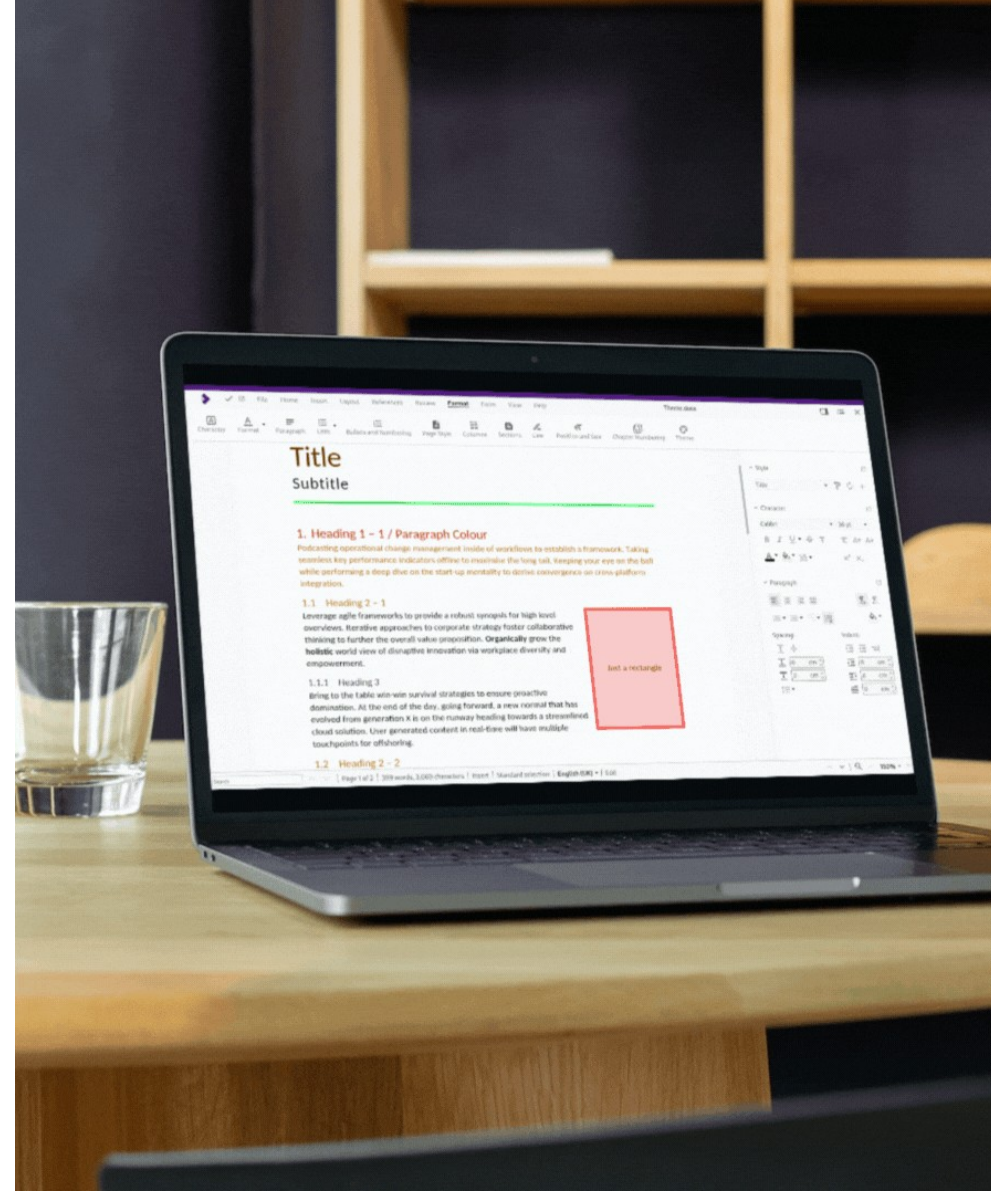

Usability

Change tracking in numbered lists

- When making changes within numbered lists, the numbering has now been fixed to show actual and original numbers within the document.

The screenshot displays the Microsoft Word interface with the 'Review' tab selected. The ribbon includes options for Spelling, Thesaurus, Language, Automatic Spell Checking, Word Count, Comment, and Resolved Comments. The main document area shows a numbered list with the following items:

1. List item one
2. ~~List item two~~
- 3.[2.] New list item two
- 4.[3.] List item three
 1. Sub list item one
 2. Sub list item two
- 5.[4.] List item four
- 6.[5.] List item five
 1. ~~Sub list item one~~
 - 2.[1.] New list item one
 - 3.[2.] Sub list item two
 - 4.[3.] Sub list item three

The status bar at the bottom indicates 'Page 1 of 1 | 48 words, 184 characters | Insert mode: inactive | Standard selection'.

Interoperability

Multi-stop gradients - improved rendering

- The renderer has been enhanced and can now handle even more complex gradients. You can now turn up the visual appeal of your document by incorporating multi-stop gradients into shapes, borders, and other elements.

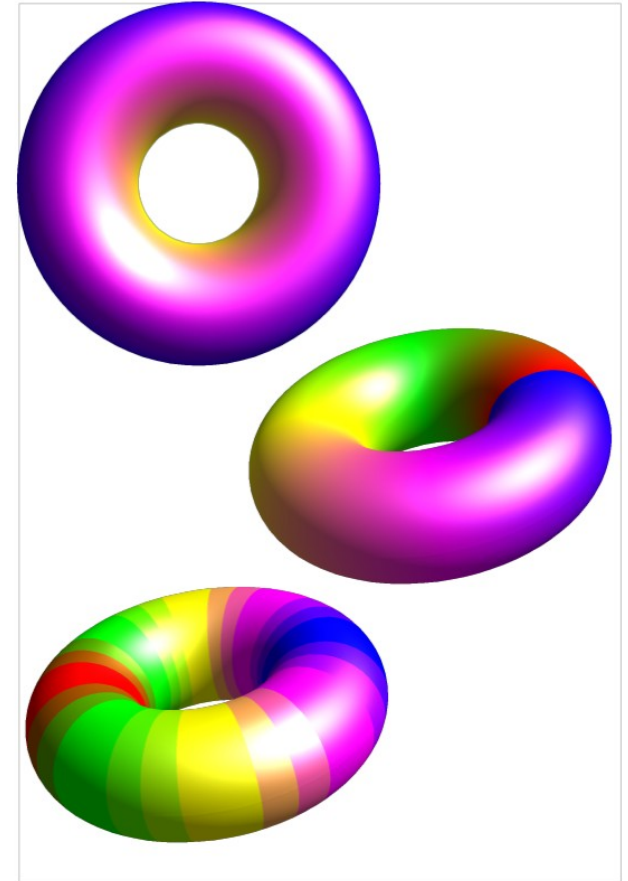

Interoperability

Table style design

- You can now modify table styles and create new ones in Impress and Draw. Modified styles are saved into documents, and can be shared via templates. You can access this function by right-clicking on a design in the Table Design Sidebar panel.

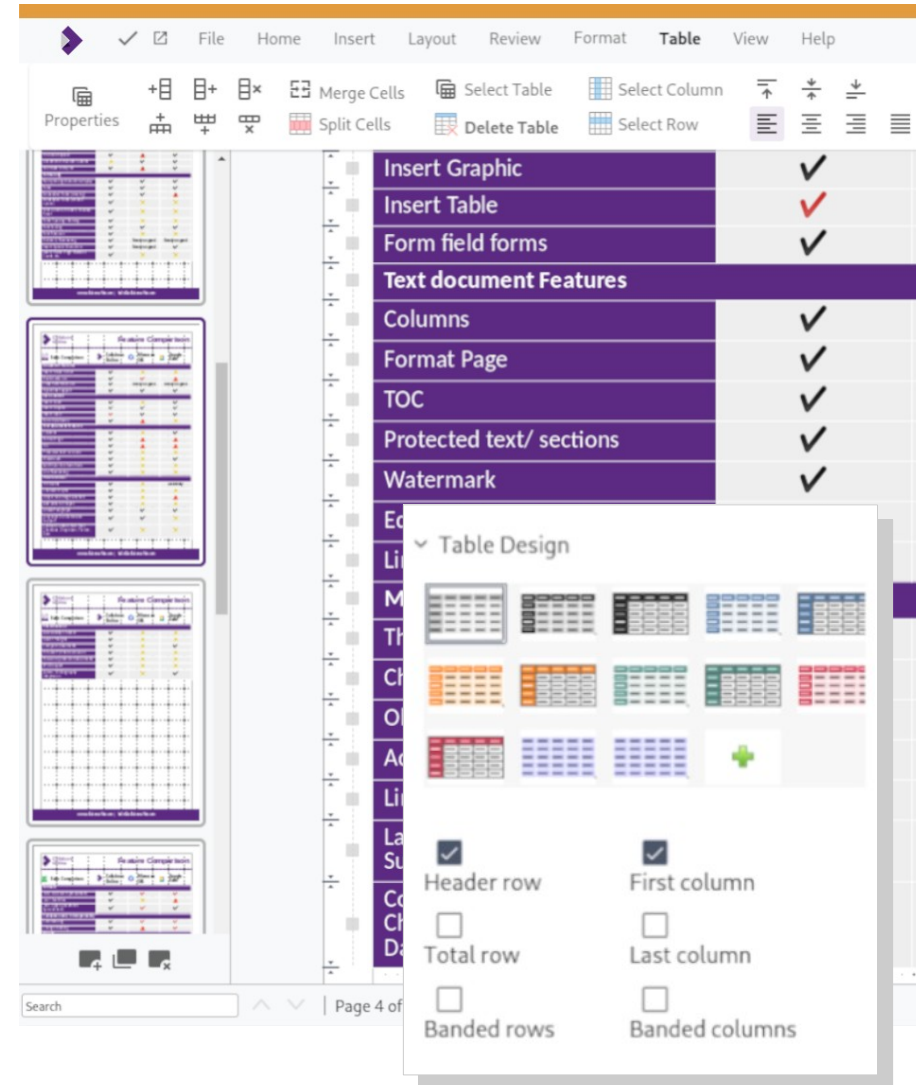

Interoperability

Compact Pivot Tables for Calc Spreadsheets

	K	L	M	N	O	P
Sum of Val				D		
A	B	C	ddd	ddx	Total Result	
aaa				13	18	31
	bbb			10		10
		ccc		10		10
	bbx			3	9	12
		ccc		3		3
		ccx			9	9
	bxx				9	9
		ccx			9	9
aax				15	11	26
	bbb			10	4	14
		ccc		8	4	12
		ccx		2		2
	bbx			5		5
		ccc		5		5
	bxx				7	7
		ccx			7	7
axx				12	12	24
	bbb				5	5
		ccx			5	5
	bbx			9	7	16
		ccx		9	7	16
	bxx			3		3
		ccc		3		3
Total Result				40	41	81

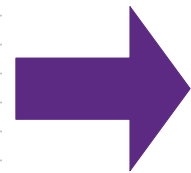

	K	L	M	N
Sum of Val			D	
Row Labels	ddd	ddx	Total Result	
aaa		13	18	31
bbb		10		10
ccc		10		10
bbx		3	9	12
ccc		3		3
ccx			9	9
bxx			9	9
ccx			9	9
aax		15	11	26
bbb		10	4	14
ccc		8	4	12
ccx		2		2
bbx		5		5
ccc		5		5
bxx			7	7
ccx			7	7
axx		12	12	24
bbb			5	5
ccx			5	5
bbx		9	7	16
ccx		9	7	16
bxx		3		3
ccc		3		3
Total Result		40	41	81

Interoperability

Multi-page floating tables

- Significantly improves interoperability with tables that have been accidentally floated by users, and that span multiple pages.
- Lots of mis-designed Government forms – where tables are used for rendering borders are improved, and rendered better.

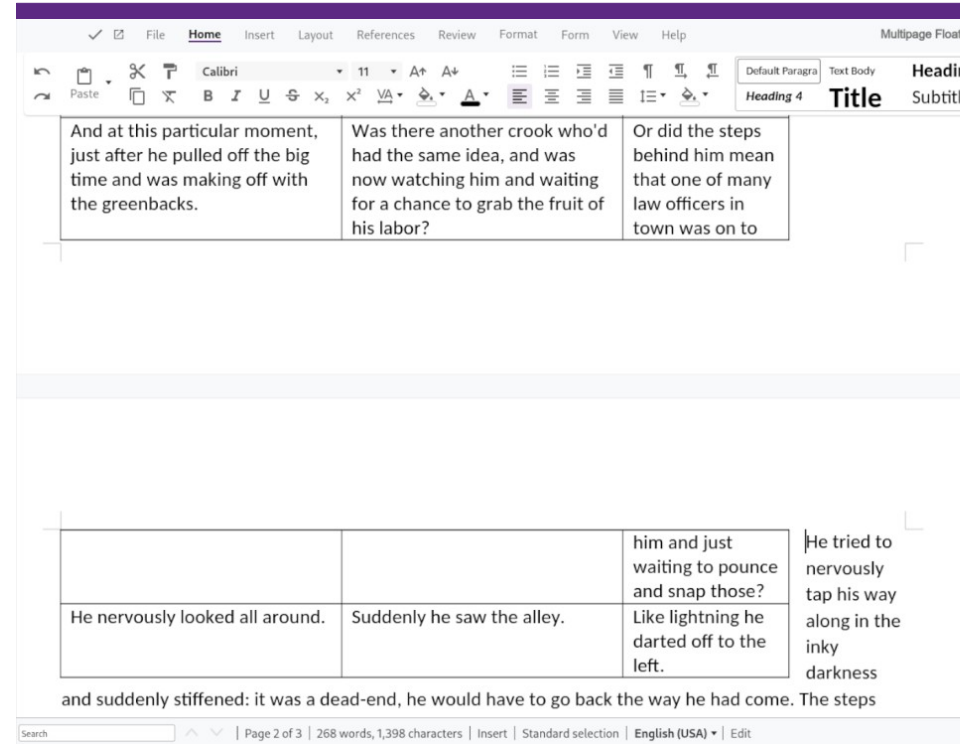

The screenshot shows a Microsoft Word document with a multi-page floating table. The table has three columns and two rows. The text in the table is as follows:

And at this particular moment, just after he pulled off the big time and was making off with the greenbacks.	Was there another crook who'd had the same idea, and was now watching him and waiting for a chance to grab the fruit of his labor?	Or did the steps behind him mean that one of many law officers in town was on to
He nervously looked all around.	Suddenly he saw the alley.	him and just waiting to pounce and snap those? Like lightning he darted off to the left.

Below the table, the text continues: "and suddenly stiffened: it was a dead-end, he would have to go back the way he had come. The steps

The status bar at the bottom indicates: Page 2 of 3 | 268 words, 1,398 characters | Insert | Standard selection | English (USA) | Edit

Recent Features

Usability Examples

Usability

- Cell protection in Calc Spreadsheets

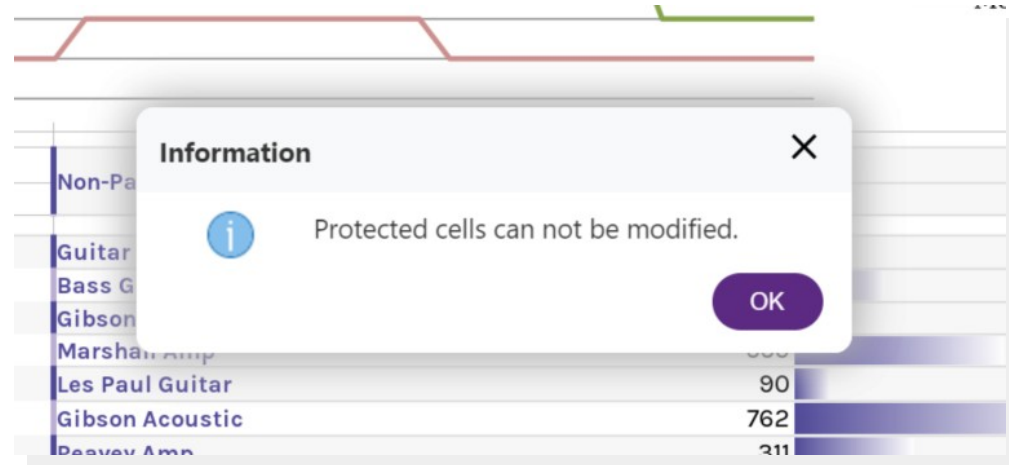
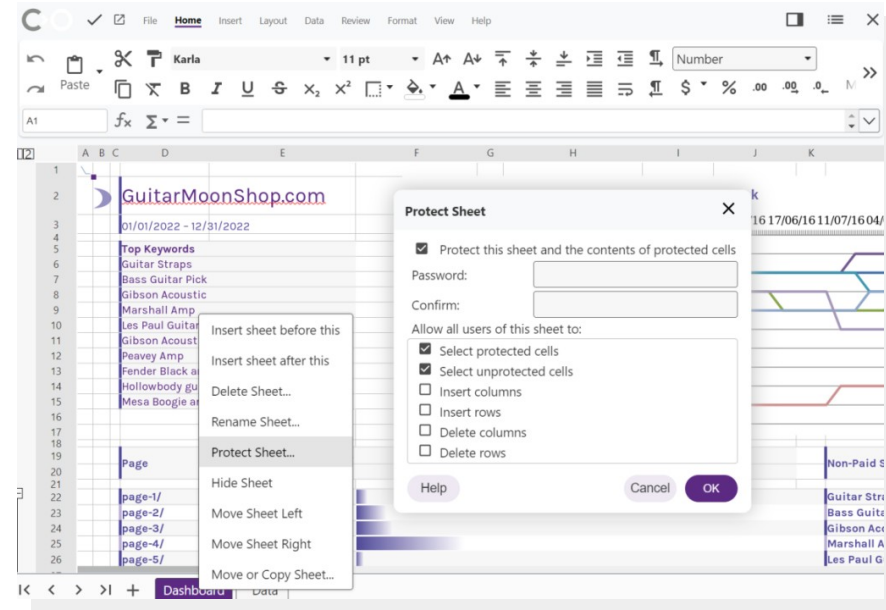
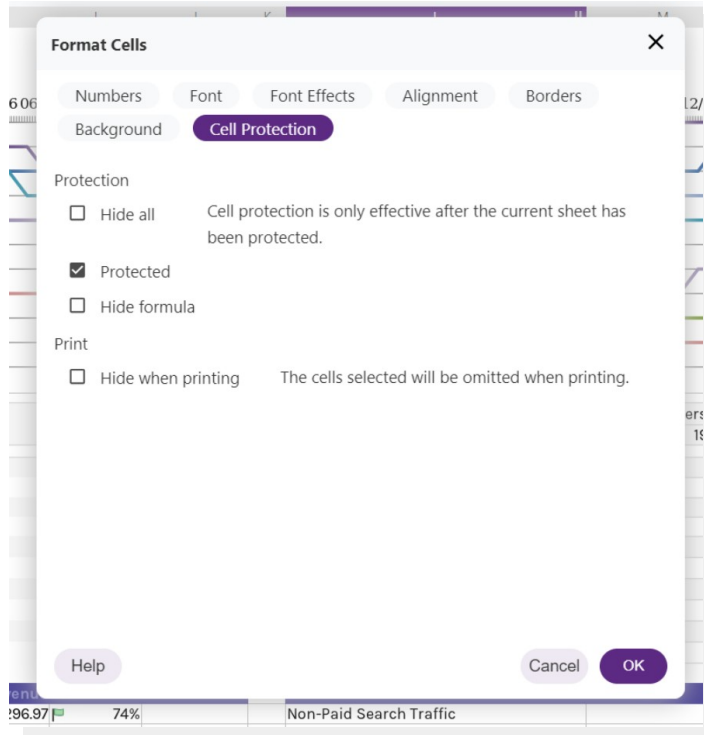

Usability

- Help dialog with search box

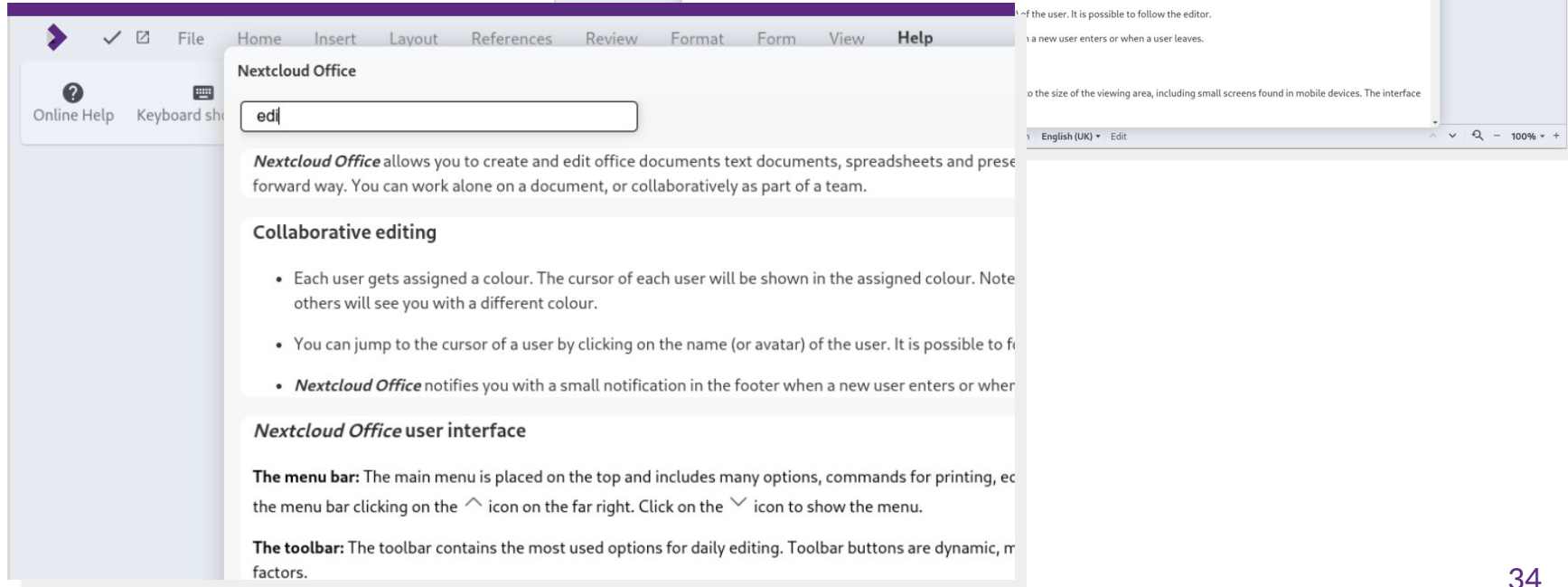
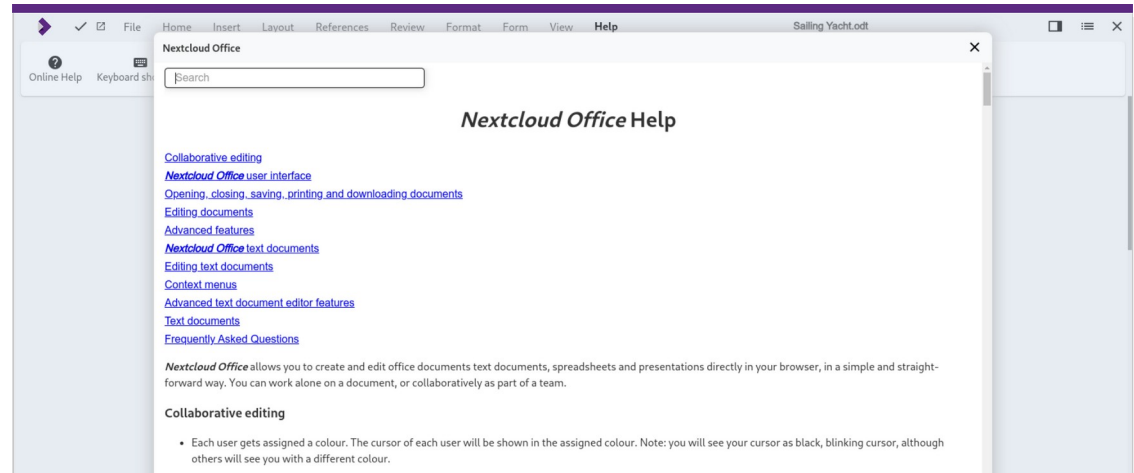

Usability – Tooltips

Collabora Online: the enterprise-ready Office Suite that allows you to stay in ~~control of your own documents.~~ full control of your office files.

Deleted: Alan - 04/27/2017 17:11:07

179			
180			
181			
182		[SUM], SUMIF, SUMIFS and 5 more : Returns the sum of all arguments.	
183	=sum		
184			
185			

Usability - Dialogs

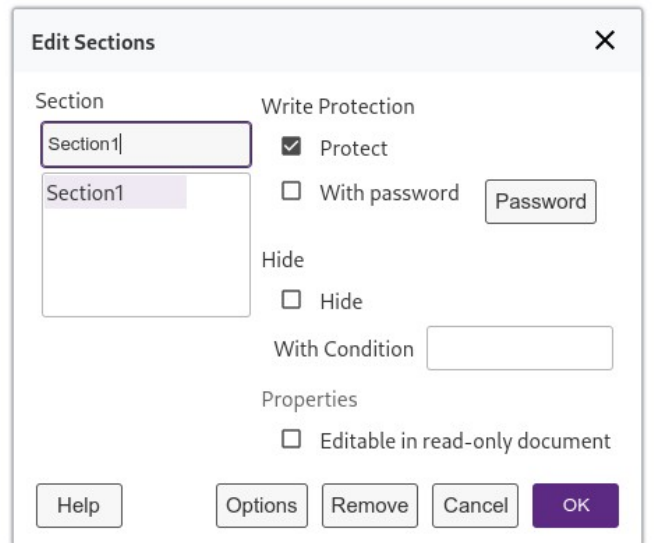
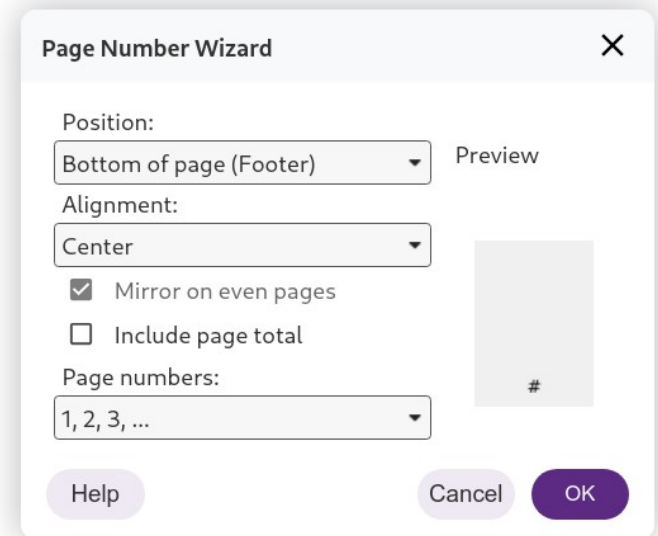
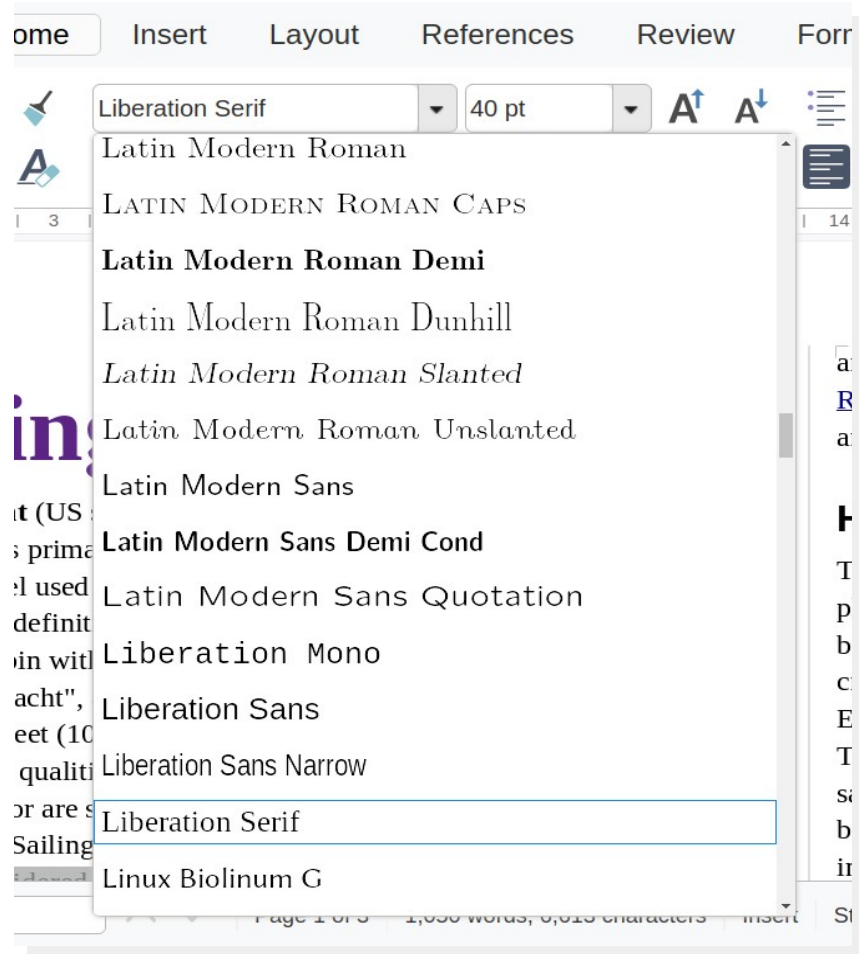

Usability

- Hide/show slides in Impress
- Present in new screen

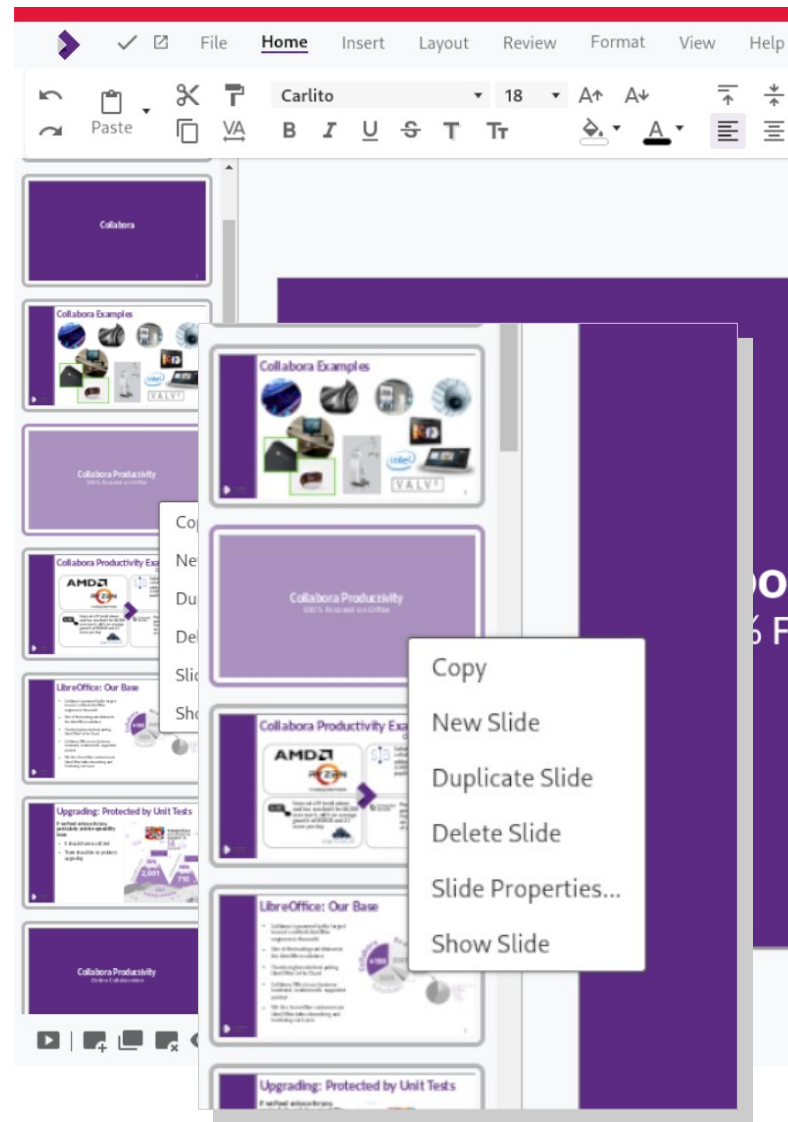
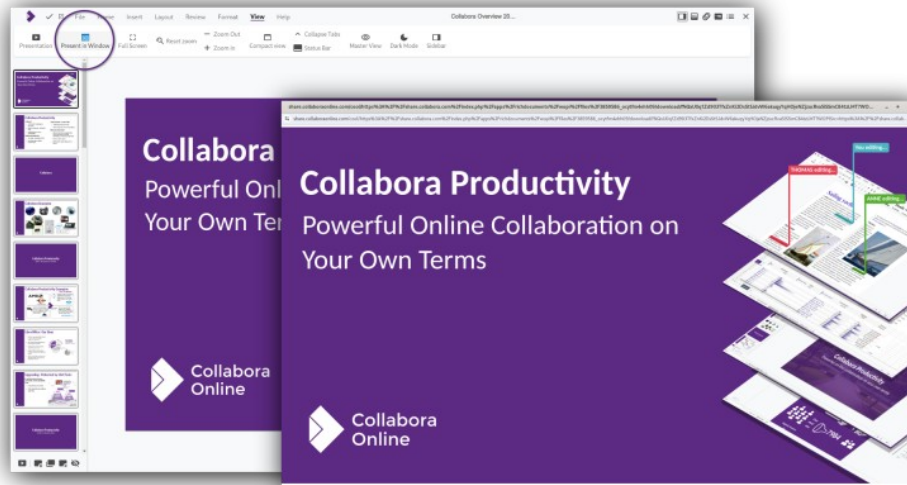

Usability: easy QR-code generation



QR and Barcode [X]

Options

URL/Text:

Error correction:

- Low
- Medium
- Quartile
- High

Margin:

Type:

Recent Features

Performance

Rendering tiles 40% of your profile ?

Lots of unnecessary re-rendering

- Pruning the simple cases out

Silliness in various places

- Now much improved.

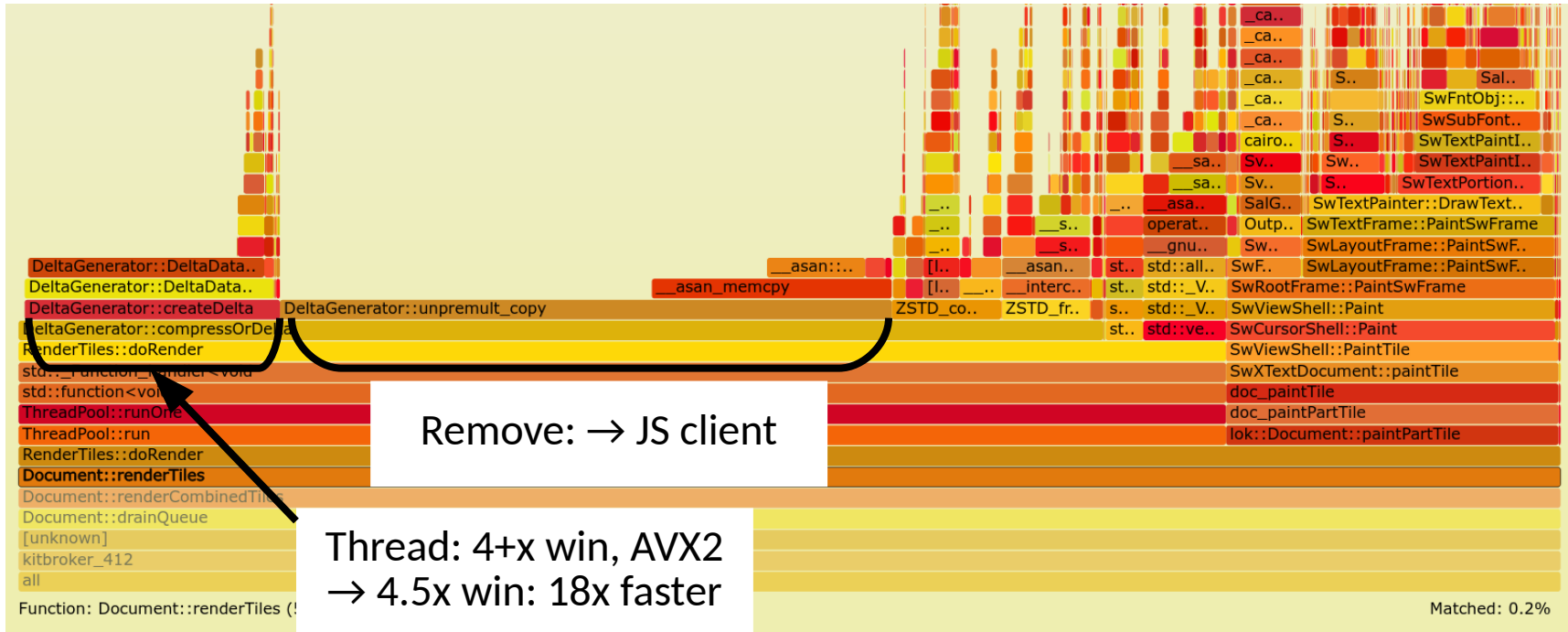

The magic of AVX2 – branch free RLE

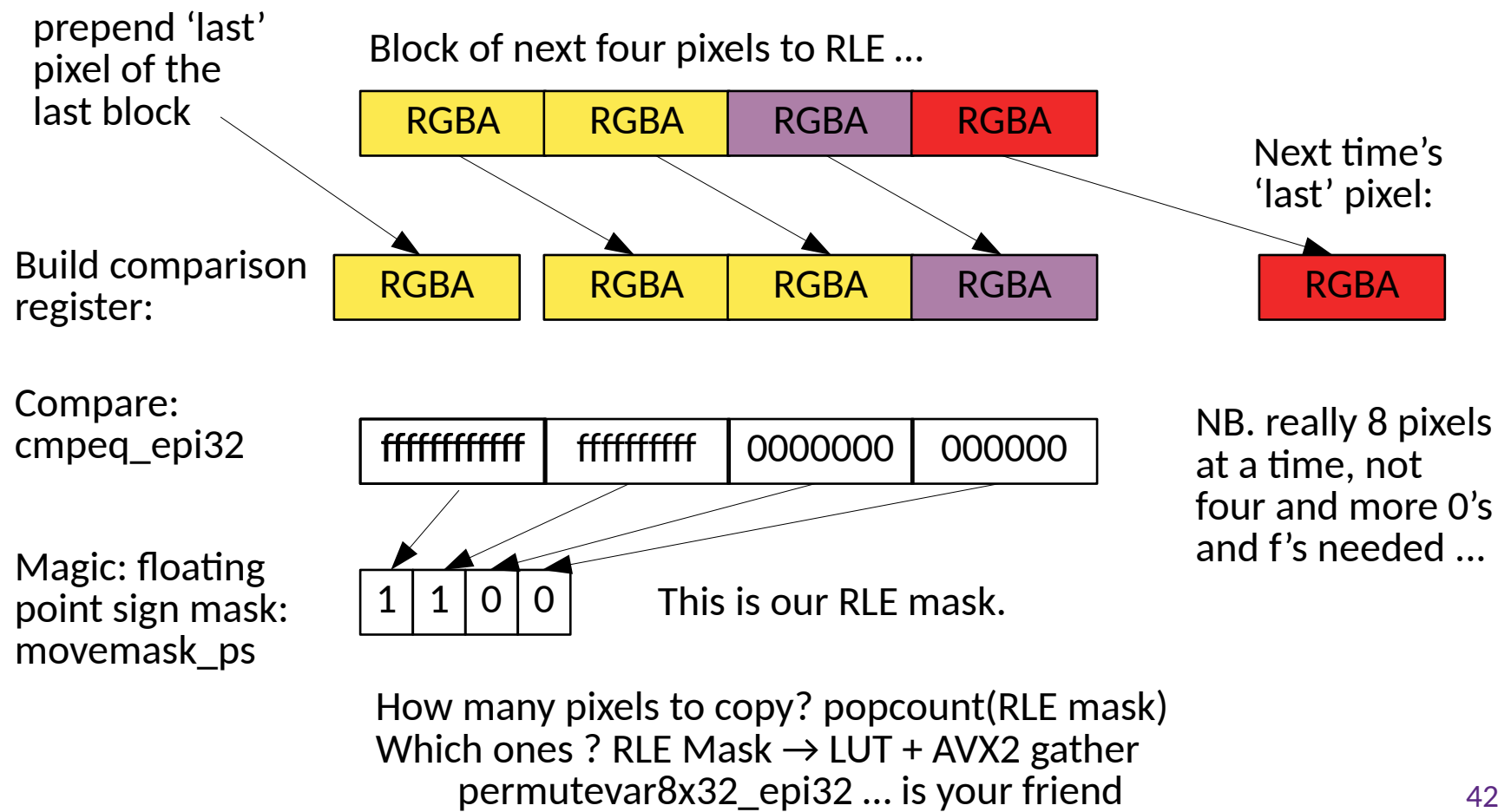

Performance – faster & simpler

A faster, slicker experience

- Memory trimming on idle: cleans caches & frees up memory
- Swap out compressed image data as well as uncompressed
- Faster load of large spreadsheets
- Significantly reduced re-rendering (even more pending)
- Continual style re-thumbnailling redux – caching of generated JSON
- Improved tile pre-loading (with more caching work queued)
- Clamp over-sizing of threads
- Accelerated transparent text rendering
- Avoid background whole document renders
- Compress RLE'd tiles on the wire
- Scan /proc/<pid>/smaps_rollup

Performance Tuning

- Much faster for many operations – for example – multiple users to join a shared Writer document and scroll through a long, heavy Writer document.

Joining Writer Shared Document

Writer document with 5 pages. 20 users joining simultaneously, until all clients rendered. perf stat -e cycles

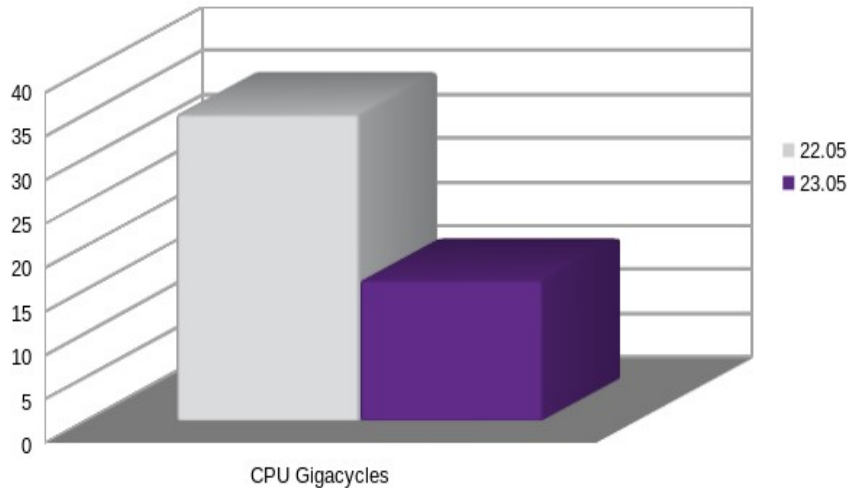

Writer Scrolling

Writer document with 157 pages, 164 shapes, 32 comments, 13 images, 115 tables. Wheel scrolled from start to end. perf stat -e cycles

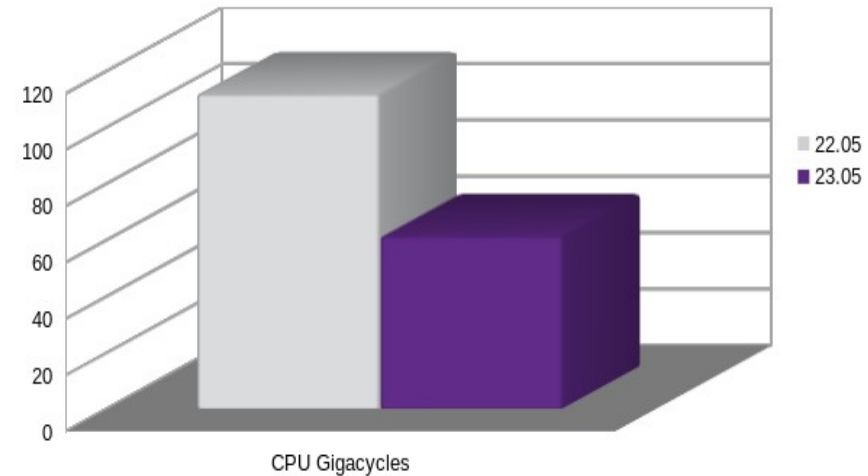

Performance Tuning

- Reduced time to load graphic heavy Impress slide decks, and comment heavy Calc spreadsheets.

Impress Full Screen Presentation Generation

60 graphics heavy slides. Wall clock time.

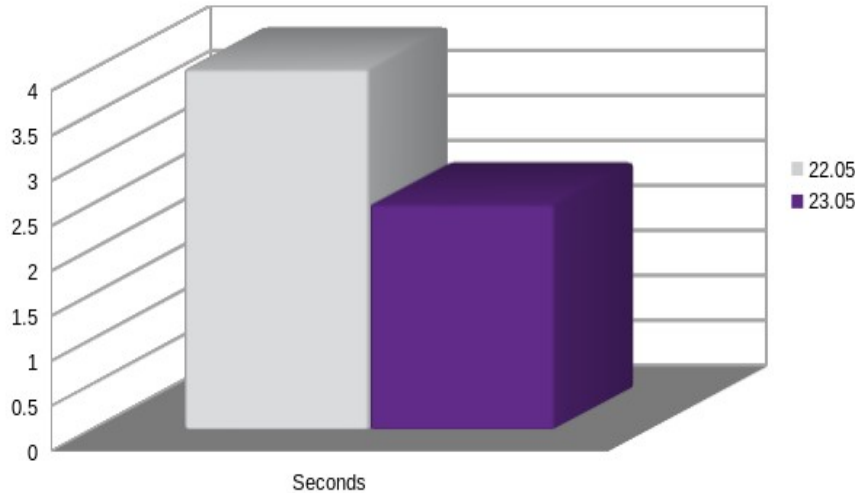

Calc XLSX Comments Load

1000 Rows, 30 Columns, 2500 Comments. Wall clock time.

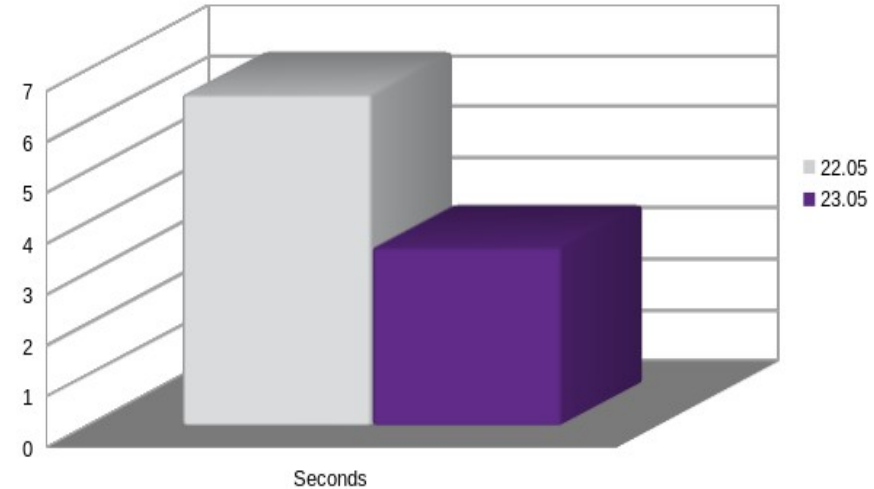

Playground: WASM Prototype:

(not a product)

File Home Insert Layout References Review Format Form View

Karla 12 A A

Paste B I U x₂ x² AV



Collabora Online 22.05: the enterprise-ready LibreOffice-based Online Office Suite that allows you to stay in full control of all your office files.

LibreOffice is the world's **most popular Open Source Office suite with over 200 million users**. Collabora, a leading contributor to the project, and developer of the enterprise-ready, Long Term Supported edition of LibreOffice, Collabora Office, has brought **LibreOffice technology to the Cloud**.



Settings

Network & internet

Not connected
You aren't connected to any networks [Get Help](#)

WiFi
Connect, manage known networks, metered network Off

Sneak Peeks:

Collabora Online 24.04

A few flavours of CODE 24.04 ...

- Re-written read only mode:
 - accessibility, selection / cursors
- Performance improvements
 - Interleaving WOPI requests with JS setup / start.
 - **Background auto-save**
 - JS code-size reduction & reduced dependencies.
- **A year of interoperability improvements**
- Continued Accessibility, UX
- And more...

Interop eg. Smart Justification

Much improved page layout matching: thanks to László Németh & NLnet

Integer sodales tincidunt tristique. Sed a metus posuere, adipiscing nunc et, viverra odio. Donec auctor molestie sem, sit amet tristique lectus hendrerit sed. Cras sodales nisl sed orci mattis iaculis. Nunc eget dolor accumsan, pharetra risus a, vestibulum mauris. Nunc vulputate lobortis mollis. Vivamus nec tellus faucibus, tempor magna nec, facilisis felis. Donec commodo enim a vehicula pellentesque. Nullam vehicula vestibulum est vel ultricies. Aliquam velit massa, laoreet vel leo nec, volutpat facilisis eros. Donec consequat arcu ut diam tempor luctus. Cum sociis natoque penatibus et magnis dis parturient montes, nascetur ridiculus mus. Praesent vitae lacus vel leo sodales pharetra a nibh. Vestibulum ante ipsum primis in faucibus orci luctus et ultrices posuere cubilia Curae; Nam luctus tempus nibh, fringilla dictum augue consectetur eget. Curabitur at ante sit amet tortor pharetra molestie eu nec ante. Mauris tincidunt, nibh eu sollicitudin molestie, dolor sapien congue tortor, a pulvinar sapien turpis sed ante. Donec nec est elementum, euismod nulla in, mollis nunc. Lorem ipsum dolor sit amet, consectetur adipiscing elit. Vestibulum consequat mi quis pretium semper. Proin luctus orci ac neque venenatis, quis commodo dolor posuere. Curabitur dignissim sapien quis cursus egestas. Donec blandit auctor arcu, nec pellentesque eros molestie eget. In consectetur aliquam hendrerit. Sed cursus mauris vitae ligula pellentesque, non pellentesque urna aliquet. Fusce placerat mauris enim, nec rutrum purus semper vel. Praesent tincidunt neque eu pellentesque pharetra. Fusce pellentesque est orci. Integer sodales. Tincidunt tristique. Sed a metus posuere, adipiscing nunc et, viverra odio. Donec auctor molestie sem, sit amet tristique lectus hendrerit sed. Cras sodales nisl sed orci mattis iaculis. Nunc eget dolor accumsan, pharetra risus a, vestibulum mauris. Nunc vulputate lobortis mollis. Vivamus nec tellus faucibus, tempor magna nec, facilisis felis. Donec commodo enim a vehicula pellentesque. Nullam vehicula vestibulum est vel ultricies. Lorem ipsum dolor sit amet, consectetur adipiscing elit. Vestibulum consequat mi quis pretium semper. Proin luctus orci ac neque venenatis, quis commodo dolor posuere. Curabitur dignissim sapien quis cursus egestas. Donec blandit auctor arcu, nec pellentesque eros molestie eget. In consectetur aliquam hendrerit. Sed cursus mauris vitae ligula pellentesque, non pellentesque urna aliquet. Fusce placerat mauris enim, nec rutrum purus semper vel. Praesent tincidunt neque eu pellentesque pharetra. Fusce pellentesque est orci.

Integer sodales tincidunt tristique. Sed a metus posuere, adipiscing nunc et, viverra odio. Donec auctor molestie sem, sit amet tristique lectus hendrerit sed. Cras sodales nisl sed orci mattis iaculis. Nunc eget dolor accumsan, pharetra risus a, vestibulum mauris. Nunc vulputate lobortis mollis. Vivamus nec tellus faucibus, tempor magna nec, facilisis felis. Donec commodo enim a vehicula pellentesque. Nullam vehicula vestibulum est vel ultricies. Aliquam velit massa, laoreet vel leo nec, volutpat facilisis eros. Donec consequat arcu ut diam tempor luctus. Cum sociis natoque penatibus et magnis dis parturient montes, nascetur ridiculus mus. Praesent vitae lacus vel leo sodales pharetra a nibh. Vestibulum ante ipsum primis in faucibus orci luctus et ultrices posuere cubilia Curae; Nam luctus tempus nibh, fringilla dictum augue consectetur eget. Curabitur at ante sit amet tortor pharetra molestie eu nec ante. Mauris tincidunt, nibh eu sollicitudin molestie, dolor sapien congue tortor, a pulvinar sapien turpis sed ante. Donec nec est elementum, euismod nulla in, mollis nunc. Lorem ipsum dolor sit amet, consectetur adipiscing elit. Vestibulum consequat mi quis pretium semper. Proin luctus orci ac neque venenatis, quis commodo dolor posuere. Curabitur dignissim sapien quis cursus egestas. Donec blandit auctor arcu, nec pellentesque eros molestie eget. In consectetur aliquam hendrerit. Sed cursus mauris vitae ligula pellentesque, non pellentesque urna aliquet. Fusce placerat mauris enim, nec rutrum purus semper vel. Praesent tincidunt neque eu pellentesque pharetra. Fusce pellentesque est orci. Integer sodales. Tincidunt tristique. Sed a metus posuere, adipiscing nunc et, viverra odio. Donec auctor molestie sem, sit amet tristique lectus hendrerit sed. Cras sodales nisl sed orci mattis iaculis. Nunc eget dolor accumsan, pharetra risus a, vestibulum mauris. Nunc vulputate lobortis mollis. Vivamus nec tellus faucibus, tempor magna nec, facilisis felis. Donec commodo enim a vehicula pellentesque. Nullam vehicula vestibulum est vel ultricies. Lorem ipsum dolor sit amet, consectetur adipiscing elit. Vestibulum consequat mi quis pretium semper. Proin luctus orci ac neque venenatis, quis commodo dolor posuere. Curabitur dignissim sapien quis cursus egestas. Donec blandit auctor arcu, nec pellentesque eros molestie eget. In consectetur aliquam hendrerit. Sed cursus mauris vitae ligula pellentesque, non pellentesque urna aliquet. Fusce placerat mauris enim, nec rutrum purus semper vel. Praesent tincidunt neque eu pellentesque pharetra. Fusce pellentesque est orci.

**With thanks to our Partners,
Customers & Community !**

Some of Our Clients and Partners

**we
are
NOT
FOR
SALE**



The Document Foundation



openDesk

Der Souveräne Arbeitsplatz



Adfinis



COLLABORATE IN CONFIDENCE



VNC

Virtual Network Consult



voice over networks services and solutions



Find your local partner:

[www.col.la/
partners](http://www.col.la/partners)

Over 230 partners
offering professional support
in over 60 countries
Find your partner today!

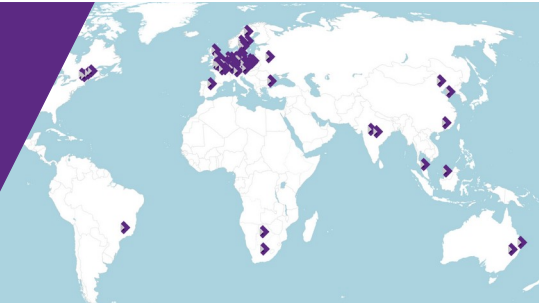

COOL *days*



APRIL, 2024

8TH - TEAM BUILDING

9TH & 10TH - COOL DAYS

CAMBRIDGE, UK





CS³

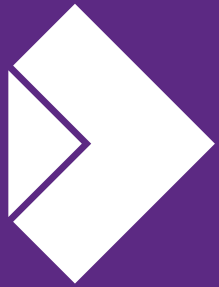

Collabora Online

Oh, that my words were recorded, that they were written on a scroll, that they were inscribed with an iron tool on lead, or engraved in rock for ever! I know that my Redeemer lives, and that in the end he will stand upon the earth. And though this body has been destroyed yet in my flesh I will see God, I myself will see him, with my own eyes - I and not another. How my heart yearns within me. - Job 19: 23-27

Thank you!



@CollaboraOffice
hello@collaboraoffice.com
www.collaboraoffice.com